



PoE Lighting Solution  
Powered by LED Industries

<b>PROJECT:</b>
<b>TYPE:</b>

# FARFALLA SERIES DOWNLIGHT

With high-performance optical elements and an elegant round downlight, the FARFALLA series is impressive for its simplicity and flexibility. Supplied with changeable collars, FARFALLA elements in various colors can create an excellent atmosphere. The FARFALLA series not only provides a comfortable illumination experience but also serves as a stylish decoration for interior areas. The space transforms with either subtle or dramatic contrasts.



**Shape**  
(Baffle Size)



**Mountings**

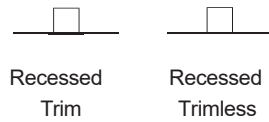

**Light distributions**

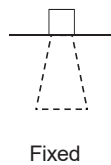

## Color available



Custom collar colours:



(MOQ is required for custom colours)



## RECESSED/ SURFACE All In One

With the ingenious mechanics, FARFALLA achieves to ensure the display effect is highlighted can produce a smooth and mild atmosphere from top to bottom. FARFALLA could adjust the application depend on different environment, it could be surface downlight if you add the collar and recessed without collar, customized color of collar is also available, high efficiency low glare and a comfortable visual experience can be precisely created.



PoE Lighting Solution  
Powered by LED Industries

LI-FAR2 (2") round  
fixed



### Specification

3000 K  
CRI ≥ 90  
TRIAC, 1-10V

### Types

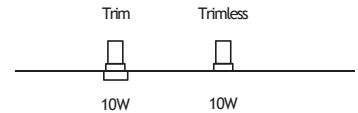

### Colours

Baffle : ● White  
● Black

Collar : ● White  
● Black

Custom collar colours:



(MOQ is required for custom colours)

### Beam Angle



120°/25°/40°/50° (Lens)



Recessed trimless



PoE Lighting Solution  
Powered by LED Industries

LI-FAR2-RTL1



Article number	2318.203-LEA-09B
LED Consumption	10W
Current	500 (mA)
Delivered Lumen	758 (lm)
Beam Angle	20°/25°/40°/50° (Lens)
CCT	3000K
CRI	90+

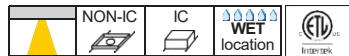

**Dimmable**

TRIAC	1-10V
-------	-------

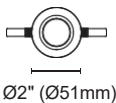
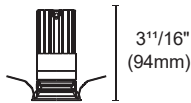

Ⓢ Cut out : 1 7/32" (45mm)

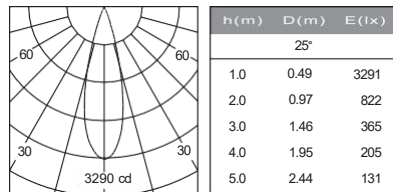

LI-FAR2-RTLF



Article number	2318.203F-LEA-09B
LED Consumption	10W
Current	500 (mA)
Delivered Lumen	758 (lm)
Beam Angle	20°/25°/40°/50° (Lens)
CCT	3000K
CRI	90+

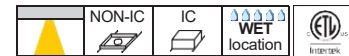

**Dimmable**

TRIAC	1-10V
-------	-------

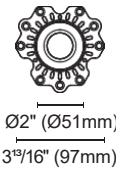
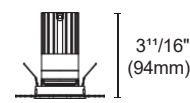

Ⓢ Cut out : 2 2/32" (60mm)

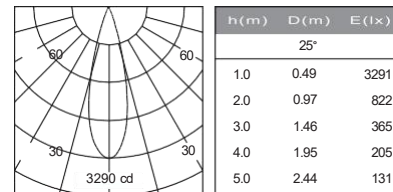

**Accessories**



ACHO-18  
honeycomb louver  
+PC sheet



SG-002  
Striped Glass



FA50-COLLAR  
Collar



PoE Lighting Solution  
Powered by LED Industries

### LI-FAR3.4 (3.5") round fixed



1/16"(23mm)

### Specification

3000 K  
CRI ≥ 90  
913 lm  
DALI, TRIAC, 1-10V

### Types

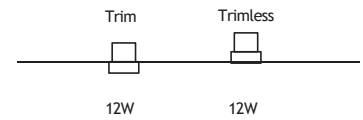

### Colours

Baffle :   
Black White

Collar :   
Black White

Custom collar colours:



Brass Copper Satin Nickel

(MOQ is required for custom colours)

### Beam Angle



15°/24°/36°/50° (Lens)



Recessed trimless



PoE Lighting Solution  
Powered by LED Industries

LI-FAR3.4-RTF1



Article number	2218.207-LEA-01
Fixture Consumption	12W
Current	250 (mA)
Lumen	913 (lm)
Beam Angle	15°/24°/36°/50° (Lens)
CCT	3000K
CRI	90+
Driver Model	PUP10A-1WMC-350

LI-FAR3.4-RTLFL

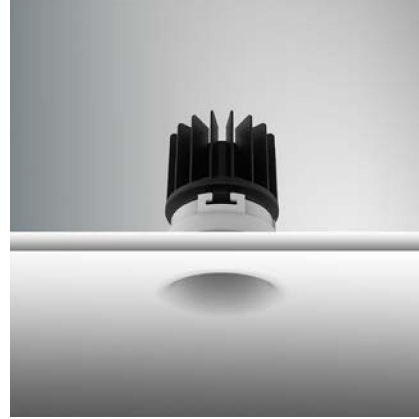

Article number	2218.207F-LEA-01
Fixture Consumption	12W
Current	250 (mA)
Lumen	913 (lm)
Beam Angle	15°/24°/36°/50° (Lens)
CCT	3000K
CRI	90+
Driver Model	PUP10A-1WMC-350



**Dimmable**

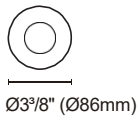
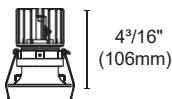

Cut out : 2 9/32" (75mm)



**Dimmable**

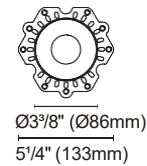

Cut out : 3 7/32" (82mm)

**Accessories**



SG7-1  
Striped glass

H7-1  
Honeycomb louver

DS7-1  
Diffusion sheet

WG7-1  
Woven glass

ACOT-34  
Collar



PoE Lighting Solution  
Powered by LED Industries

LI-FAR4.4 (4.5") round  
fixed



### Specification

3000 K  
CRI ≥ 90  
913 lm  
DALI, TRIAC, 1-10V

### Types

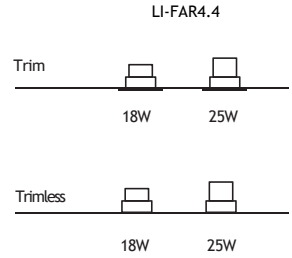

### Colours

Baffle :    
Black White

Collar :    
Black White

Custom collar colours:



Brass Copper Satin Nickel  
(MOQ is required for custom colours)

### Beam Angle



15°/24°/36°/50° (Lens)



Recessed trimless



PoE Lighting Solution  
Powered by LED Industries

LI-FAR4.4-RTF1

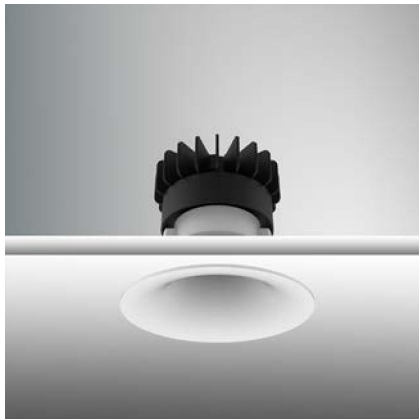

LI-FAR4.4-RTLFL

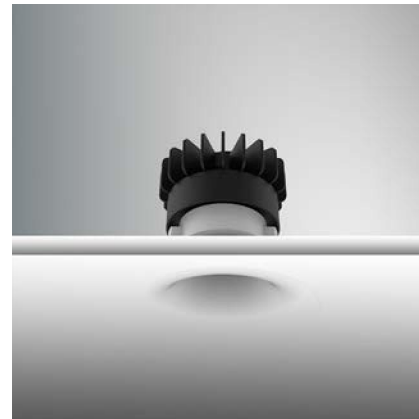

Article number	2318.223-LEA-15
Fixture Consumption	21W
Current	500 (mA)
Lumen	2004 (lm)
Beam Angle	15°/24°/36°/50° (Lens)
CCT	3000K
CRI	90+
Driver Model	PUP20A-1WMC

Article number	2318.223F-LEA-15
Fixture Consumption	21W
Current	500 (mA)
Lumen	2004 (lm)
Beam Angle	15°/24°/36°/50° (Lens)
CCT	3000K
CRI	90+
Driver Model	PUP20A-1WMC

Article number	2318.223-LEA-15-DW
Fixture Consumption	18W
Current	450 (mA)
Lumen	34-1507 (lm)
Beam Angle	15°/24°/36°/50° (Lens)
CCT	1800-3000K
CRI	90+
Driver Model	PUP20A-1WMC

Article number	2318.223F-LEA-15-DW
Fixture Consumption	18W
Current	450 (mA)
Lumen	34-1507 (lm)
Beam Angle	15°/24°/36°/50° (Lens)
CCT	1800-3000K
CRI	90+
Driver Model	PUP20A-1WMC



**Dimmable**

	TRIAC	1-10V
--	-------	-------

**Dimmable**

	TRIAC	1-10V
--	-------	-------

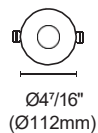

Ø4 7/16" (Ø116mm)



8 1/16" (205mm)

Cut out : 3 9/32" (100mm)

Cut out : 5 1/32" (128mm)

**Accessories**



SG7-1 Striped glass    H7-1 Honeycomb louver    DS7-1 Diffusion sheet    WG7-1 Woven glass    FA110-COLLAR Collar





PoE Lighting Solution  
Powered by LED Industries

LI-FAR4.4-RTF1

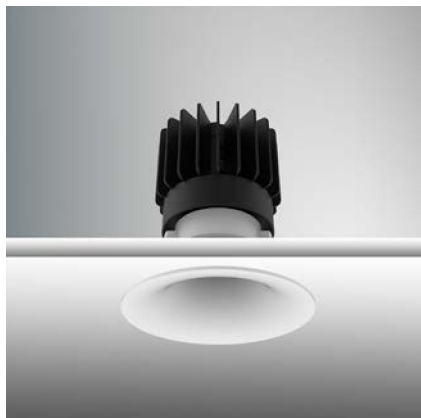

**Article number 2318.223-ACOT-84-AM**

	NON-IC	IC
Fixture Consumption	30W	25W
Current	700 (mA)	600 (mA)
Lumen	2873 (lm)	- (lm)
Beam Angle	15°/24°/36°/50° (Lens)	
CCT	3000K	
CRI	90+	
Driver Model	PUP40A-1WMC-850	

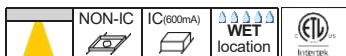

**Dimmable**

	TRIAC	1-10V
--	-------	-------

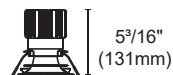

Cut out : 3 9/32" (100mm)

LI-FAR4.4-RTL1F

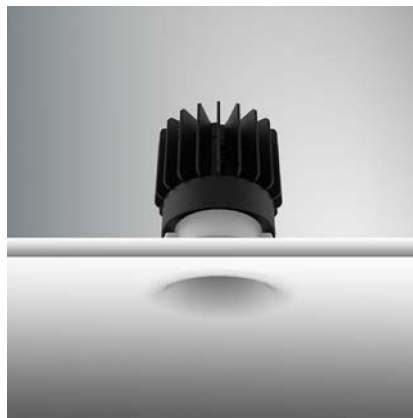

**Article number 2318.223F-ACOT-84-AM**

	NON-IC	IC
Fixture Consumption	30W	25W
Current	700 (mA)	600 (mA)
Lumen	2873 (lm)	- (lm)
Beam Angle	15°/24°/36°/50° (Lens)	
CCT	3000K	
CRI	90+	
Driver Model	PUP40A-1WMC-850	

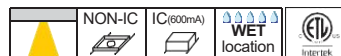

**Dimmable**

	TRIAC	1-10V
--	-------	-------



Ø4 7/16" (Ø116mm)



8 1/16" (205mm)

Cut out : 5 1/32" (128mm)

**Accessories**



SG7-1  
Striped glass

H7-1  
Honeycomb louver

DS7-1  
Diffusion sheet

WG7-1  
Woven glass

FA110-COLLAR  
Collar



PoE Lighting Solution  
Powered by LED Industries

PROJECT:

TYP  
E:

## Farfalla Series

### Certification Information



NON-IC



IC



### SPECIFICATIONS

Designed based on the concept of "light engine modularization", making Farfalla downlight possible to be more flexible, more practical and expandable.

The features are as follows:

- \* Modularized design - easy maintenance & replacement
- \* Maximize common components to reduce stock cost
- \* Speed up the progress of new Farfalla development in the future
- \* Interchangeable design to increase product flexibility
- \* Set up design norms by modularization, minimize possible faults

### Optics

Deep baffle design helps reduce glare, equipped with special selected lens, the light is evenly spread towards the centre to achieve the beam angles needed, making the Farfalla a unique downlight.

#### • Compliance

All combinations of fixtures, trims ETL Listed.

#### • Type

Trim, Trimless

#### • Shape

Round

#### Beam Angle



15°/24°/36°/50° (Lens)

#### • Diffuser



SG7-1 Striped Collar glass  
H7-1 Honeycomb louver  
DS7-1 Diffusion sheet  
WG7-1 Woven glass  
FA110-COLLAR

#### Colors

Baffle :   
Black White

Collar :   
Black White

Custom collar colours:



Brass Copper Satin Nickel

(MOQ is required for custom colours)

Selectable Power	30W Max
Shape	Round
Input voltage	PoE: 0.277 - 0.833 Amps A/C : 120-277 VAC
Selectable Lumens	750 - 2850lm
CRI	>90Ra
Beam Angle	15°, 24°, 36°, 50°
Color Temp	1800K, 2700K, 3000K TW 18-30K
Dimensions	Dia: 2" - 4.5" Height: 3 <sup>11</sup> / <sub>16</sub> " - 5 <sup>3</sup> / <sub>16</sub> "
Material	Aluminum
Dimming	PoE, DALI, TRIAC
Certificate	ETL
Warranty	3 years

### ORDERING INFO:

EXAMPLE: LI-FRLA-3.5-12-2-R-TR-2-2-30-H7-1-NON-IC-WHT-WHT

SERIES	SIZE	WATTAGE	LUMEN	SHAPE	TYPE	BEAM ANGLE	CRI	CCT	DIFFUSER	HOUSING	BAFFLE FINISH	COLLAR FINISH

SERIES	SIZE	WATTAGE	LUMEN	SHAPE	TYPE	BEAM ANGLE	CRI	CCT	DIFFUSER	HOUSING	BAFFLE FINISH	COLLAR FINISH
LI-FRLA	2 - Ø 2"	10 - 10W	1 - 750lm	R - ROUND	TR - TRIMMED TL - TRIMLESS	1 - 15°	1 - >80 2 - >90	18 - 1800K 27 - 2700K 30 - 3000K	SG7-1 - Striped Glass	IC - IC Rated Housing NON-IC - New Construction Plate	WHT - WHITE BLK - BLACK	WHT - WHITE BLK - BLACK BRS - BRASS CPR - COPPER NKL - NICKEL
	3.5 - Ø 3.5"	12 - 12W	2 - 920lm			2 - 24°			H7-1 - Honeycomb louver			
	4.5 - Ø 4.5"	18 - 18W 21 - 21W 25 - 25W 30 - 30W	3 - 1500lm 4 - 2000lm 5 - 2400lm 6 - 2800lm			3 - 36° 4 - 50°			DS7-1 - Diffusion sheet WG7-1 - Woven glass COL - Collar			



PoE Lighting Solution  
Powered by LED Industries

## INSTALLATION OPTIONS

**Conforms to UL STD. 2108**  
**Certified to CSA STD.C22.2 NO.9**



**KIG-040-DWJ**

Triac/Phase , 0-10V , 1-10V , Potentiometer ,  
10V PWM 5 in 1 dimming  
40W 1~3T  
for LI-FAR2 (2")  
Type: Gear box

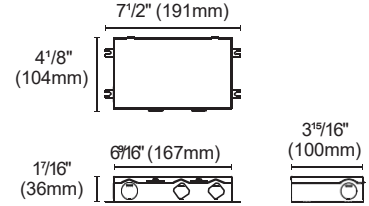

**ACCH-12-61X181 +  
ACCI-10-R45-R60**

Cut out:  
Round : 1 9/32" (45mm)  
Round : 2 2/32" (60mm)

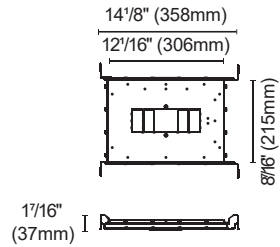

\* Need to match the cutout accessories



**ACCH-12G-61X181 +  
ACCI-10-R45-R60**

Cut out:  
Round : 1 9/32" (45mm)  
Round : 2 2/32" (60mm)

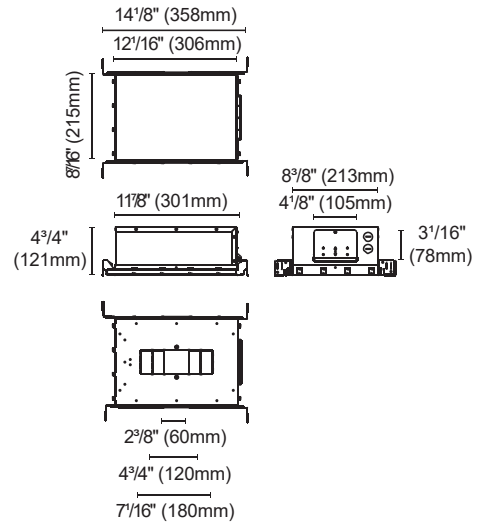

\* Need to match the cutout accessories

**Cutout accessories**

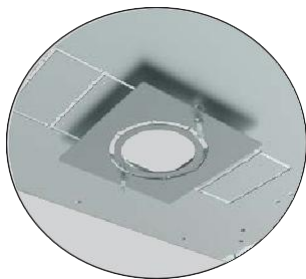

**ACCI-10-R45-R60**

Cut out:  
Round : 1 9/32" (45mm)  
Round : 2 2/32" (60mm)



PoE Lighting Solution  
Powered by LED Industries

## INSTALLATION OPTIONS

**Conforms to UL STD. 1598**  
**Certified to CSA STD.C22.2 NO.250.0**



### ACCH-12-R75-R85

for LI-FAR3.4-3.5" both trim & trimless

Type: New construction plate

Cut out:

Round : 2<sup>9</sup>/<sub>32</sub>" (75mm)

Round : 3<sup>1</sup>/<sub>32</sub>" (85mm)

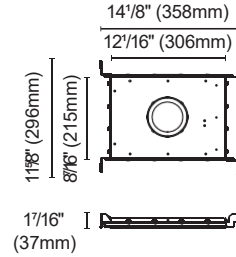

### ACCH-12H-100

for LI-FAR4.4-4.5" trim

Type: New construction plate

Cut out:

Round : 3<sup>9</sup>/<sub>32</sub>" (100mm)

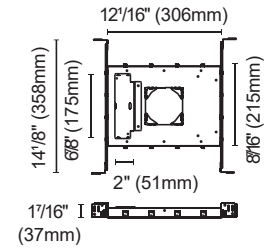

### ACCH-12H-128

for LI-FAR4.4-4.5" trimless

Type: New construction plate

Cut out:

Round : 5<sup>1</sup>/<sub>32</sub>" (128mm)

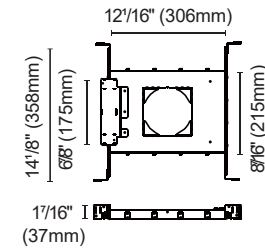

### ACCI-3

Type: Emergency battery holder

For BillDa emergency led driver-

Model NO. BLD-HM08D-YYY

BLD-HM15D-YYY

BLD-HM20D-YYY

BLD-HM25D-YYY

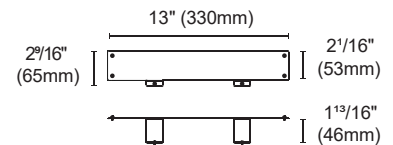



PoE Lighting Solution  
Powered by LED Industries



**ACCH-12B-100-PUP20A-1WMC** 0/1-10V  
**ACCH-12B-100-PUP20D-1WMC** DALI  
**ACCH-12B-100-PUP20T-1LMC** TRIAC  
 for LIFAR4.4-4.5" trim (18-21W)  
 Type: IC Box  
Cut out:  
 Round : 3<sup>9</sup>/<sub>32</sub>" (100mm)

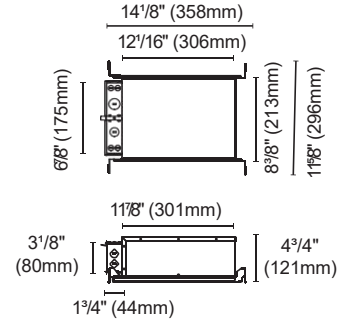

**ACCH-12B-128-PUP20A-1WMC** 0/1-10V  
**ACCH-12B-128-PUP20D-1WMC** DALI  
**ACCH-12B-128-PUP20T-1LMC** TRIAC  
 for LI-FAR4.4-4.5" trimless (18-21W) Type: IC  
 Box  
Cut out:  
 Round : 5<sup>1</sup>/<sub>32</sub>" (128mm)



**ACCH-7B-100-PUP40A-1WMC-850** 0/1-10V  
**ACCH-7B-100-PUP40D-1WMC-850** DALI  
**ACCH-7B-100-PUP40T-1LMC-850** TRIAC  
 for LI-FAR4.4-4.5" trim (25W)  
 Type: IC Box  
Cut out:  
 Round : 3<sup>9</sup>/<sub>32</sub>" (100mm)

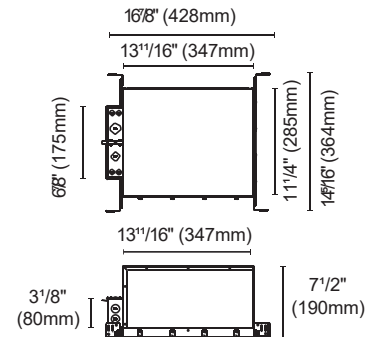

**ACCH-7B-125-PUP40A-1WMC-850** 0/1-10V  
**ACCH-7B-125-PUP40D-1WMC-850** DALI  
**ACCH-7B-125-PUP40T-1LMC-850** TRIAC  
 for LI-FAR4.4-4.5" trimless (25W)  
 Type: IC Box  
Cut out:  
 Round : 5<sup>1</sup>/<sub>32</sub>" (128mm)